

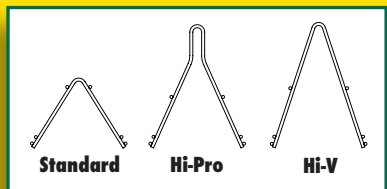

Flat Chain Feeding At Its Finest.

Flat Chain Feeding Systems

VAL-CO® offers you a choice of suspended or floor model components — and a choice of equipment for weighing feed inside or outside the house. VAL-CO flat chain drive hoppers are powder painted with welded steel construction and high quality gear reducers. Adjustable feed gate and remix wheel keeps the right amount of fresh feed in the trough.



Male exclusion grill is available in your choice of styles – Standard, Hi-Pro and Hi-V.

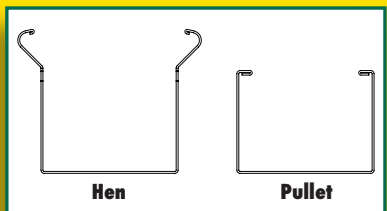

Trough is available for hens and pullets.

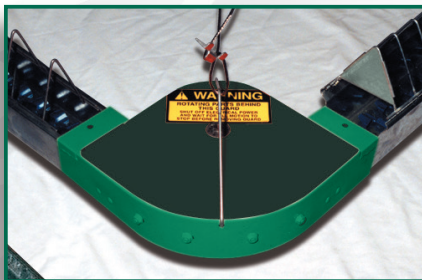

Suspended corner assembly and trough corners.

VAL-CO corners have fluted wheel with oil impregnated brass bushing for long life.

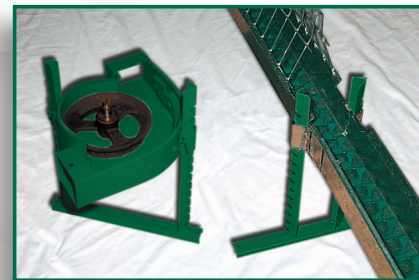

Floor stands offer wide footing to keep the trough and corners secure and properly aligned. Height is fully adjustable.

(WARNING: Corner cover is removed to show internal parts. The corner cover MUST be secured in place before system is operated.)

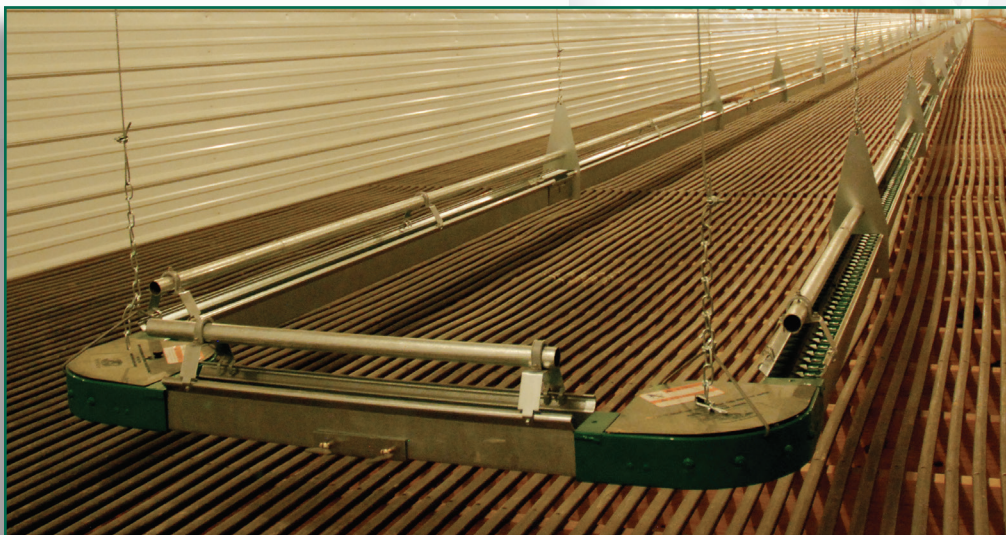

Performance You Can Count On

Hanging Pan Feeders

Use the Hanging Pan Feeders to increase feeding space. The 8 spoke steel grill is strong and durable.

The pans come standard with an integrated shutoff that keeps the towers from filling with feed when closed. The adjustable collar allows user to vary feed capacity. Internal feed restrictor included to reduce tower capacity.

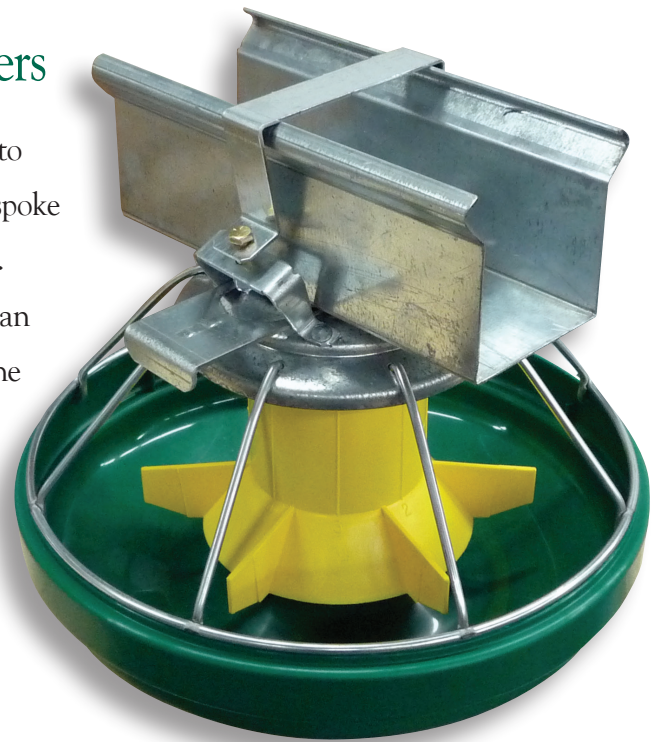

Choose between 2 models. Reference the table below.

Part Number	DIM A	DIM B	DIM C
455160	12.24" (31.1cm)	5.04" (12.8cm)	8.74" (22.2cm)
455180	11.35" (28.8cm)	4.16" (10.6cm)	7.79" (19.8cm)

Diameter: 13.0" (33.0cm)

Circumference: 40.8" (103.6cm)



The Hanging Pan Feeders easily retrofit onto existing Flat Chain Feeding Systems.

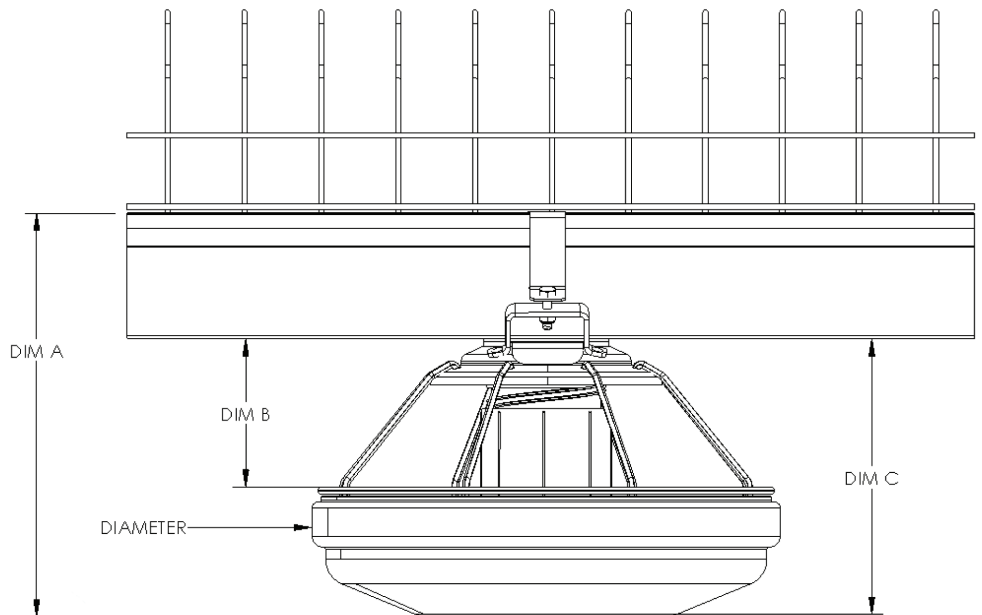

Call your local **VAL-CO** representative or distributor for more information on this and other fine quality products.

North America:

Phone: 800-99VALCO (800-998-2526)

Fax: (+1) 419-678-2200

E-mail: sales@val-co.com

International:

Phone: (+1) 419-678-8731

Fax: (+1) 419-678-2200

E-mail: intl.sales@val-co.com



Performance You Can Count On

www.val-co.com