



---

## **SECTION 10 SIDE BELT NESTS**

### **IN THIS CATALOG SECTION**

<b>PAGE NUMBER</b>	<b>CONTENTS</b>
10-02	How To Order A Side Belt Mechanical Nest & Egg Collection System
10-03	Collection Tables - End Return - 4" Egg Belt
10-04	Side Belt Nests
10-05	Connector Trough & Cover Assemblies
10-06	Collection Table Diagrams

### **REPAIRS**

SEE REPAIR LISTING IN SEPARATE CATALOG
--

---

## SIDE BELT NESTS

### HOW TO ORDER A SIDE BELT MECHANICAL NEST & EGG COLLECTION SYSTEM

1. Select one collection table for each nest row based on electrical requirement, height requirement and if used with cross conveyor or not.
2. Select one 412180 Dual Roller End Return for each collection table.
3. Select the nest required (16 hole or 20 hole) and determine the correct quantity needed based on nests per station and connector length.
4. Select one Nest Pad set for each nest.
5. Determine the quantity and select the roll length of cloth or perforated polypropylene 4" egg belt needed.
6. Select one 410185 Glue Kit per two rows of nests when using cloth egg belt.
7. Select one 410127 Sewing Kit for per two rows of nests when using cloth egg belt.
8. When polypropylene egg belt is used, select two 413552 Splicing Strapping for each nest row.
9. When using polypropylene egg belt, select one 412539 Egg Belt Take Up Tensioner Kit for each collection table.
10. Determine the length required for each nest-to-table connector, then select two connector trough & cover units for each collection table.
11. Determine the nest-to-nest connector needed based on the crossover space required and/or nest row length, then select the quantity of connector trough & cover units required.

#### **OPTIONS**

1. Select one 412268 Egg Deflector Kit for each nest; if not supplied locally, include two 412276 PVC pipes per kit.
2. Select one 412267 Nest Lid Opening/Closing Kit per nest.

## SIDE BELT MECHANICAL NEST & EGG COLLECTION

### COLLECTION TABLES

CATALOG #	ITEM DESCRIPTION	SHIP WEIGHT		LIST PRICE
		LBS.	KG.	
412620	3/4 hp Collection Table - 115V	258.8	117.4	
412621	3/4 hp Collection Table - 115V, Includes XH Legs (adds up to 10" / 25.4cm)	271.7	123.2	
412622	3/4 hp Collection Table - 230V	259.0	117.5	
412623	3/4 hp Collection Table - 230V, Includes XH Legs (adds up to 10" / 25.4cm)	269.0	122.0	
412539	Polypropylene egg belt take up tensioner kit <b>(required collection table addition for use with polypropylene egg belts)</b>	90.1	40.9	
412624	3/4 hp Collection Table - 115v, For direct egg transfer to cross conveyor	229.0	103.9	
412625	3/4 hp Collection Table - 115V, For direct egg transfer to cross conveyor, Includes XH Legs (adds up to 10" / 25.4cm)	241.0	109.3	
412626	3/4 hp Collection Table - 230V, For direct egg transfer to cross conveyor	234.0	106.1	
412627	3/4 hp Collection Table - 230V, For direct egg transfer to cross conveyor, Includes XH Legs (adds up to 10" / 25.4cm)	247.0	112.0	
412686-Q2	4" Egg Belt wide Drive Transfer Assembly (Quantity 2) <i>(1) 412686-Q2 For use with cross conveyor collection tables 412624, 412625, 412626, &amp; 412627</i>	5.2	2.4	

### FAR END RETURN ASSY

CATALOG #	ITEM DESCRIPTION	SHIP WEIGHT		LIST PRICE
		LBS.	KG.	
412180	Dual Roller End Return Assembly	30.0	13.6	

### CLOTH 4" EGG BELT

CATALOG #	ITEM DESCRIPTION	SHIP WEIGHT		LIST PRICE
		LBS.	KG.	
412450-0850	4" Egg Belt - 850' Roll	31.0	14.1	
412450-1050	4" Egg Belt - 1050' Roll	39.3	17.8	
412450-1250	4" Egg Belt - 1250' Roll	51.0	18.1	

### PERFORATED POLYPROPYLENE 4" EGG BELT

CATALOG #	ITEM DESCRIPTION	SHIP WEIGHT		LIST PRICE
		LBS.	KG.	
412555-0820	4" Perforated Polypropylene Egg Belt - 820' Roll	52.0	23.6	
412555-1020	4" Perforated Polypropylene Belt Egg Belt - 1020' Roll	64.0	29.0	
412555-1220	4" Perforated Polypropylene Belt Egg Belt - 1220' Roll	75.0	18.1	

### EGG BELT ACCESSORIES

CATALOG #	ITEM DESCRIPTION	SHIP WEIGHT		LIST PRICE
		LBS.	KG.	
410185	Glue Kit for Cloth Egg Belt (Includes 1 - #410186 Hot Glue Gun and 6 - #410187 Hot Glue Sticks)	1.2	0.5	
413552	Splicing Strapping for polypropylene egg belt	0.0	0.9	
410127	Sewing Kit for both Cloth (Includes 1 - #410940 3" Belt Needle & 1 - #410941 81' Spool Wax Thread)	0.1	0.0	

## SIDE BELT MECHANICAL NEST & EGG COLLECTION

### 8' - 20 HOLE MECHANICAL NEST, NEST PADS, ACCESSORIES

CATALOG #	ITEM DESCRIPTION	SHIP WEIGHT		LIST PRICE
		LBS.	KG.	
412200	8' Side Belt Nest - 20 Holes - Closeable Top <i>(10 - 9.5" Holes Per Side; order pads separately)</i>	115.0	52.2	
412300	8' Side Belt Nest - 20 Holes - Open Top <i>(10 - 9.5" Holes Per Side; order pads separately)</i>	105.0	47.6	
412203	Val-Co Finger Pad Set for 412200 Nest <i>Set includes 20 - 412229 Finger Pads (bulk packed)</i>	3.8	1.7	
412260	Astroturf® NXT Turf Pad for 412200 Side Belt Nest	0.2	0.1	
412261	Astroturf® NXT Turf Pad set of 20 for double 412200 Side Belt Nest	4.0	1.8	
412201	Original Astroturf® Pad Set for 412200 Nest <i>Set includes 20-412077 Astroturf Pads (bulk packed)</i>	3.8	1.7	
412267	Nest Lid opening/closing kit. For use with the 412200 and 412210 8' side belt nests. (1 kit required per nest. Does not include required additional winching system components)	0.7	0.3	
412268	Egg Deflector Kit, Package of 8 Brackets (1 kit per nest section. PVC pipe, 1 1/4" (31.75mm) schedule 40 not included. Also fits 16 hole nests.)	1.6	0.7	

### 8' - 16 HOLE MECHANICAL NEST AND NEST PAD

CATALOG #	ITEM DESCRIPTION	SHIP WEIGHT		LIST PRICE
		LBS.	KG.	
412210	8' Side Belt Nest - 16 Holes <i>(8 - 12" Holes Per Side; order pads separately)</i>	110.0	49.9	
412282	Astroturf® NXT Turf Pad set of 16 for double 412210 Side Belt Nest	3.2	1.5	
412213	Val-Co Finger Pad Set for 412210 Nest <i>Set includes 16 - 412229 Finger Pads (bulk packed)</i>	3.0	1.4	

### 8' - 10 HOLE COMFORT NEST AND NEST PAD

CATALOG #	ITEM DESCRIPTION	SHIP WEIGHT		LIST PRICE
		LBS.	KG.	
412460	8' Side Belt Nest - 10 Holes - Comfort Nest <i>(5- 19" Holes Per Side; order pads separately)</i>	111.5	50.6	
412479	Astroturf® NXT Turf Pad 12.1 x 18.9 for 412460 Comfort Side Belt Nest	0.8	0.4	
412267	Nest Lid opening/closing kit. For use with the 412200, 412210 and 412460 8' side belt nests. (1 kit required per nest. Does not include required additional winching system components)	0.7	0.3	
412268	Egg Deflector Kit, Package of 8 Brackets (1 kit per nest section. PVC pipe, 1 1/4" (31.75mm) schedule 40 not included. Also fits 16 hole nests.)	1.6	0.7	

## SIDE BELT MECHANICAL NEST & EGG COLLECTION

### TROUGH CONNECTORS FOR SIDE BELT NESTS

CATALOG #	ITEM DESCRIPTION	SHIP WEIGHT		LIST PRICE
		LBS.	KG.	
412070	18" Connector Trough & Cover Assembly <i>(412046 Trough + 412047 Cover)</i>	2.2	1.0	
412071	24" Connector Trough & Cover Assembly <i>(412044 Trough + 412045 Cover)</i>	2.7	1.2	
412072	28.75" Connector Trough & Cover Assembly <i>(412048 Trough + 412049 Cover)</i>	5.5	2.5	
412073	36" Connector Trough & Cover Assembly <i>(412051 Trough + 412052 Cover)</i>	4.2	1.9	
412074	48" Connector Trough & Cover Assembly <i>(412053 Trough + 412054 Cover)</i>	5.5	2.5	
412075	96" Connector Trough & Hinged Cover Assembly <i>(412056 Trough + 412057 Hinged Cover)</i>	11.0	5.0	

*Used for both nest-to-table and nest-to-nest.*

---

## SIDE BELT COLLECTION TABLE HEIGHTS

### REGULAR HEIGHT TABLE

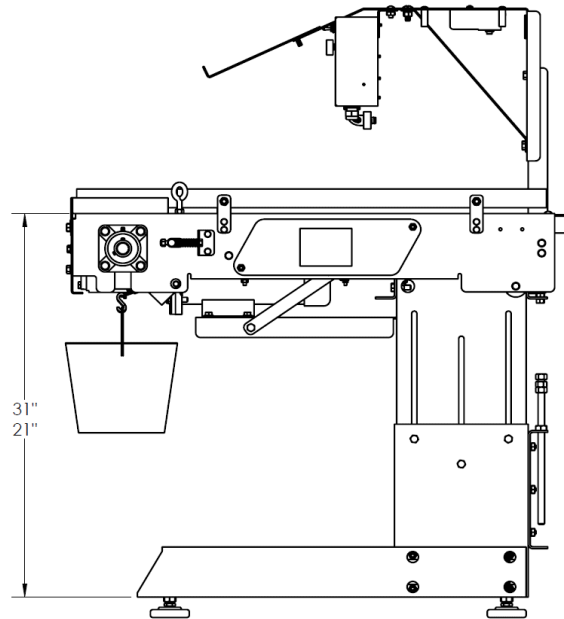

### EXTRA HEIGHT TABLE

