



SECTION 19 WINCHING

IN THIS CATALOG SECTION

PAGE NUMBER	CONTENTS
coming soon	Technical Information
19-02	Winches
19-03	Cable, Cable Accessories, and Tools
19-04	Solid Wire, Cord, Cord Accessories and Suspension Chain
19-05	Hardware for Suspending
19-06	Winching Fasteners
19-07 & 19-08	Pulleys
19-09	Anchor Brackets
19-10	Chain and Sprockets

WINCHES

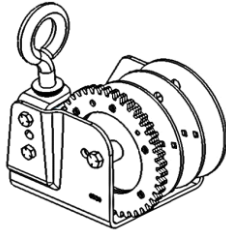

VB312

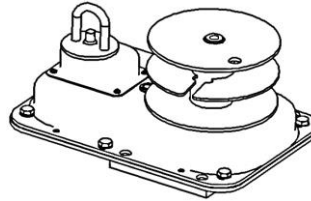

450378

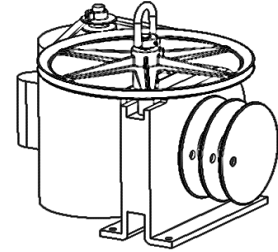

455400

OVERHEAD WINCHES

CATALOG NUMBER	ITEM DESCRIPTION	SHIP WEIGHT		LIST PRICE
		LBS.	KGS.	
VB312	2000 lb. Manual Overhead Winch	10.5	4.8	
VB321	3500 lb. Manual Overhead Winch	36.0	16.3	
VB322	3000 lb. Manual Overhead Winch	39.0	17.7	
450378	5000 lb. Manual Overhead Winch	21.1	9.6	
455400	4800 lb. Electric Overhead Winch - Motor Not Included Requires 1/2 h.p. farm duty motor - order separately from catalog section 20.	52.0	23.6	
VB313	Winch Handle 5 FT	5.0	2.3	
820172	Winch Handle Universal (4-8 Ft.) Manual or Drill Assist	9.0	4.1	
820156	Universal Winch Mounting Hardware Kit	2.0	0.9	

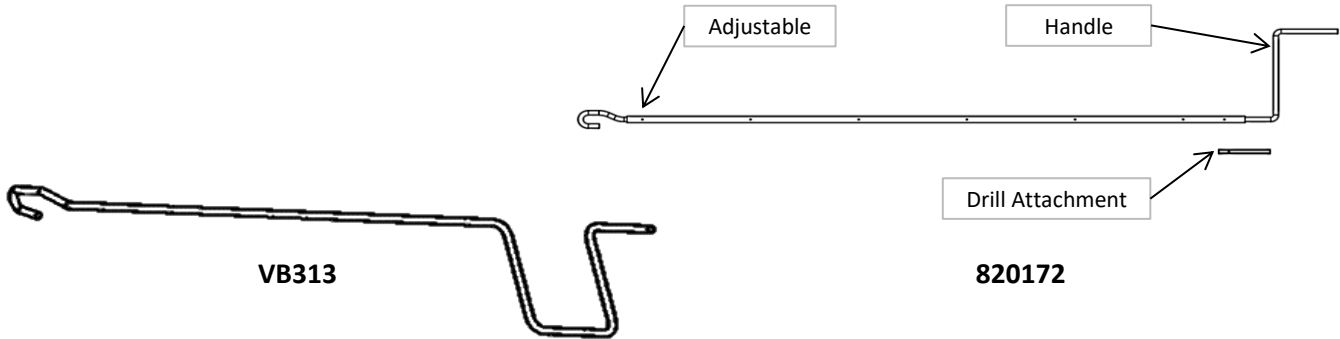

VB313

820172

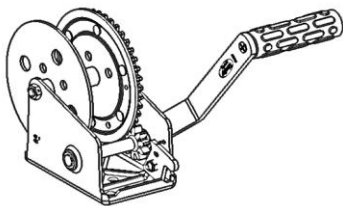

VB315

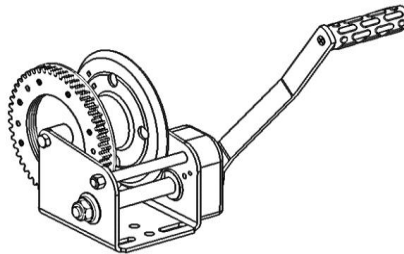

VB317

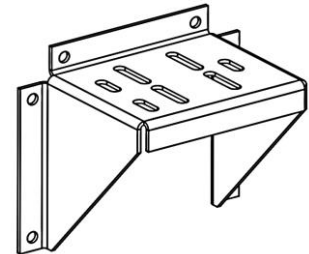

820173

HAND WINCHES

CATALOG NUMBER	ITEM DESCRIPTION	SHIP WEIGHT		LIST PRICE
		LBS.	KGS.	
VB315	1100 lb. Ratchet Winch	6.0	2.7	
VB317	1500 lb. Brake Winch	8.0	3.6	
820173	Hand Winch Mounting Bracket	3.4	1.6	
820156	Universal Winch Mounting Hardware Kit	2.0	0.9	

CABLE, CABLE ACCESSORIES, AND TOOLS

CABLE		SHIP WEIGHT		LIST PRICE
		LBS.	KGS.	
CATALOG NUMBER	ITEM DESCRIPTION			
VG342	1/16" Galvanized 7x19 Cable (Per Foot)	0.021	0.01	
VC343	1/8" Galvanized 7x7 Cable (Per Foot)	0.025	0.01	
VC350	1/8" Stainless Steel 7x7 Cable (Per Foot)	0.002	0.00	
VC351	3/16" Galvanized 7x7 Cable (Per Foot)	0.037	0.02	
VC352	3/16" Stainless Steel Cable (Per Foot)	0.005	0.00	
820122	1/4" Galvanized 7x19 Cable (Per Foot)	0.111	0.05	



VC353, 610101,
VC354, VC358,
VC355, 610161,

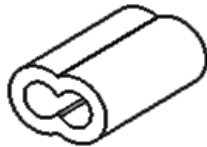

450559, 450386,
VS344, VS343

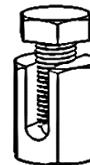

VC345



VS342

CABLE ACCESSORIES		SHIP WEIGHT		LIST PRICE
		LBS.	KGS.	
CATALOG NUMBER	ITEM DESCRIPTION			
VC353	1/16" Galvanized Cable Clamp	0.018	0.008	
VC345	1/16" - 1/8" Screw Clamp (For Anti-Roost Cable)	0.015	0.007	
610101	3/32" Galvanized Cable Clamp	0.037	0.017	
VC354	1/8" Galvanized Cable Clamp	0.015	0.007	
VC358	1/8" Stainless Steel Cable Clamp	0.015	0.007	
VC355	3/16" Galvanized Cable Clamp	0.063	0.028	
610161	3/16" Stainless Steel Cable Clamp	0.000	0.000	
820123	1/4" Galvanized Cable Clamp	0.120	0.054	
PMSLEEVE	1/16" x 1/16" Cable Sleeve	0.001	0.000	
450386	1/8" x 1/8" Cable Sleeve	0.006	0.003	
VS344	1/8" x 3/16" Cable Sleeve	0.012	0.005	
VS343	3/16" x 3/16" Cable Sleeve	0.016	0.007	
VS342	1/8" Cable Adjuster	0.058	0.026	

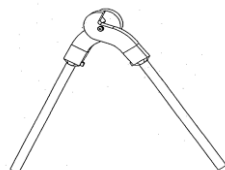

VS347

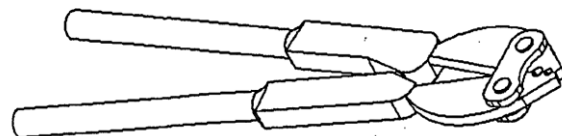

VS346

CABLE TOOLS		SHIP WEIGHT		LIST PRICE
		LBS.	KGS.	
CATALOG NUMBER	ITEM DESCRIPTION			
VS346	Swage Tool	5.6	2.527	
450291	8" Cable Cutter	0.0	0.0	
450291E	8" Cable Cutter (Economy)	0.7	0.3	
VS347	18" Cable Cutter	4.1	1.8	

SOLID WIRE, CORD, CORD ACCESSORIES, AND SUSPENSION

SOLID WIRE

CATALOG NUMBER	ITEM DESCRIPTION	SHIP WEIGHT		LIST PRICE
		LBS.	KGS.	
VEN9WIRE	Solid Galvanized Wire - 9 gauge - Per Foot	0.059	0.03	
820025	Solid Galvanized Wire - 12.5 gauge - Per Foot	0.026	0.01	

CORD

VD319	1/8" Polyester Cord (per foot)	0.004	0.00	
500668	3/16" Nylon Cord (per foot)	0.025	0.01	
VD320	1/4" Polyester Cord (per foot)	0.001	0.00	

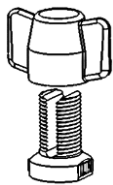

VCLAMP
VCLAMPL

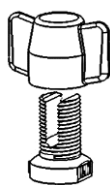

HCLAMP
HCLAMPL



VC360



VE345
VC361

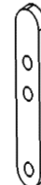

VS341



VD321

CORD ACCESSORIES

CATALOG NUMBER	ITEM DESCRIPTION	SHIP WEIGHT		LIST PRICE
		LBS.	KGS.	
VCLAMP	Plastic Cable Clamp (7/16"-14 Thread, 0.125" Slot Width) VB126 Clamp Bolt W/Long Slot (Yellow) + VB125 Nut (Yellow)	0.015	0.01	
HCLAMP	Plastic Cable Clamp (7/16"-14 Thread, 0.125" Slot Width) VB127 Clamp Bolt W/Short Slot (Blue) + VB125 Nut (Yellow)	0.012	0.005	
VCLAMPL	Plastic Cable Clamp (1/2"-13 Thread, 0.154" Slot Width) VB226 Clamp Bolt W/Long Slot (Blue) + VB225 Nut (Yellow)	0.013	0.006	
HCLAMPL	Plastic Cable Clamp (1/2"-13 Thread, 0.154" Slot Width) VB227 Clamp Bolt W/Short Slot (Blue) + VB225 Nut (Yellow)	0.017	0.008	
VC360	1/8" Open Stakon	0.006	0.002	
VE345	1/8" Regular Stakon	0.033	0.015	
VC361	3/16" Regular Stakon	0.010	0.005	
VS341	1/8" Cord Adjuster	0.014	0.006	
VD321	1/4" Cord Fid - Aluminum	0.004	0.002	

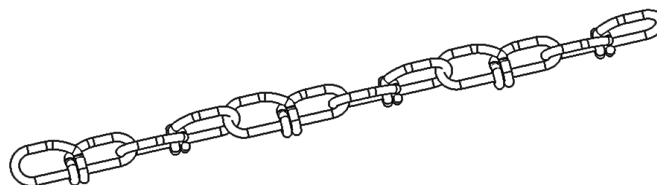

820099

SUSPENSION CHAIN

CATALOG NUMBER	ITEM DESCRIPTION	SHIP WEIGHT		LIST PRICE
		LBS.	KGS.	
820099	2/0 DOUBLE LOOP CHAIN (per foot)	0.17	0.077	

HARDWARE FOR SUSPENDING

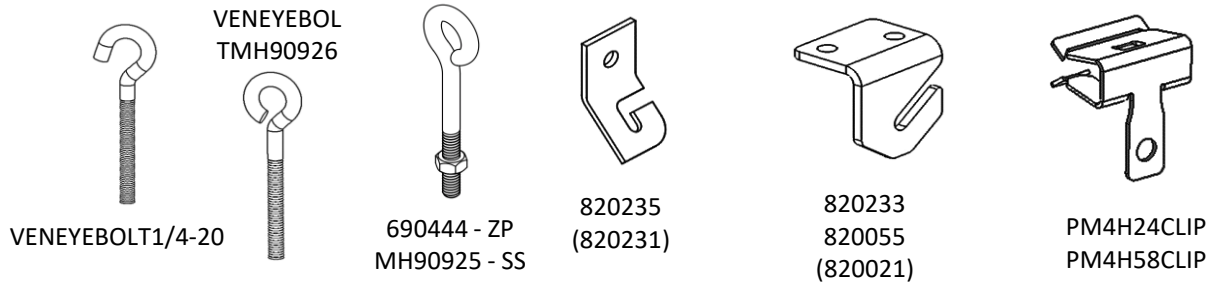

SUSPENSION (FOR STEEL)

CATALOG NUMBER	ITEM DESCRIPTION	SHIP WEIGHT		LIST PRICE
		LBS.	KGS.	
VENEBOLT1/4-20	1/4"-20 x 3" OPEN EYEBOLT	0.600	0.27	
VENEBOLT	3/8"-16 x 5" CLOSED EYEBOLT - Zinc Plated	0.000	0.00	
690444	1/4-20 x 2 1/2" Closed 1/2" I.D. Eye Bolt With Nut - Zinc Plated	0.050	0.023	
MH90925	1/4-20 x 2 1/2" Closed 1/2" I.D. Eye Bolt With Nut - Stainless Steel	0.000	0.000	
MH90926	3/8"-16 x 5" CLOSED EYEBOLT - Stainless Steel	0.000	0.000	
820235	Steel Truss Winching Bracket (box of 50 with screws) - For winching waterline and standard feedline applications - Accepts pulleys VEN91101, VEN91102, and VEN91104	4.500	2.041	
820233	Steel Truss Suspension Bracket (box of 25 with screws) - For suspension and other winching applications - Accepts pulleys VEN91101, VEN91102, and VEN91104 - Accepts suspension chain 820099	4.740	2.150	
820055	Steel Truss Suspension Bracket (box of 50 with screws) - For suspension and other winching applications - Use with pulleys VEN91101, VEN91102, and VEN91104 - Accepts suspension chain 820099	8.709	3.950	
PM4H24CLIP	I-Beam Flange Clip (1/8" - 1/4" Thick)	0.020	0.009	
PM4H58CLIP	I-Beam Flange Clip (5/16" - 1/2" Thick)	0.040	0.018	

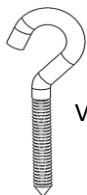

VEN91504C
 713441
 816005
 690398



VP321



VEN91507B
 VEN91507C

SUSPENSION (FOR WOOD)

CATALOG NUMBER	ITEM DESCRIPTION	SHIP WEIGHT		LIST PRICE
		LBS.	KGS.	
VEN91504C	5/16" x 3-1/2" Lag Screw Hook - Zinc Plated	0.100	0.045	
713441	5/16" x 5" Lag Screw Hook - Zinc Plated	0.100	0.045	
816005	1/2" x 3-1/2" Lag Screw Hook - Zinc Plated	0.052	0.024	
690398	1/4" x 3-1/2" Lag Screw Hook - Stainless Steel	0.072	0.033	
VP321	Galvanized J Nail - For winching standard waterlines only - Accepts pulley VEN91104	0.018	0.008	

S HOOKS

CATALOG NUMBER	ITEM DESCRIPTION	SHIP WEIGHT		LIST PRICE
		LBS.	KGS.	
VEN91507B	S Hook - .177" x 1.5"	0.020	0.009	
VEN91507C	S Hook - 1/4" x 2.25"	0.072	0.033	

WINCHING FASTENERS

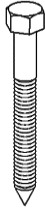

690262, 940706,
 690067, VEN91505
 690399



820234
 (690285)



690168
 690069



690147
 690061



690150
 690156

FASTENERS

CATALOG NUMBER	ITEM DESCRIPTION	SHIP WEIGHT		LIST PRICE
		LBS.	KGS.	
690262	5/16" x 1-1/2" Lag Screw	0.030	0.01	
690399	5/16" x 1-1/2" Lag Screw - Stainless Steel	0.029	0.01	
940706	5/16" x 2-1/2" Lag Screw	0.000	0.000	
690067	3/8" x 2" Lag Screw	0.054	0.024	
VEN91505	3/8" x 3" Lag Screw	0.090	0.041	
690285	1/4"-14 x 1" TEK Screw	0.014	0.006	
820234	1/4"-14 x 1" TEK Screw (QTY 55)	1.000	0.454	
690168	5/16"-18 x 1" Hex Head Bolt	0.028	0.013	
690147	5/16"-18 x 2-1/2" Hex Head Bolt	0.058	0.026	
690150	5/16"-18 x 3-1/2" Hex Head Bolt	0.069	0.031	
690069	3/8"-16 x 1" Hex Head Bolt	0.042	0.019	
690061	3/8"-16 x 2-1/2" Hex Head Bolt	0.077	0.035	
690156	3/8"-16 x 3-1/2" Hex Head Bolt	0.101	0.046	
690019	1/4"-20 Nylock Nut	0.008	0.004	
690166	5/16"-18 Nylock Nut	0.112	0.051	
690214	3/8"-16 Nylock Nut	0.002	0.001	
690038	1/4" USS Flat Washer	0.007	0.003	
690035	5/16" USS Flat Washer	0.011	0.005	
690093	3/8" USS Flat Washer	0.015	0.007	
410844	3/8" Fender Washer (1-5/8 OD)	0.039	0.018	

Note: All fasteners listed are Zinc Plated Steel, other sizes, lengths, types and materials are available upon request.



690019
 690166
 690214



690038
 690035

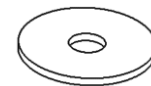

410844

PULLEYS



VEN91104
690400

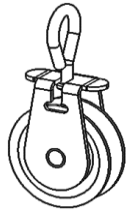

VEN91101

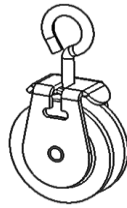

VEN91102

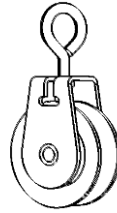

ZR1801



VEN911

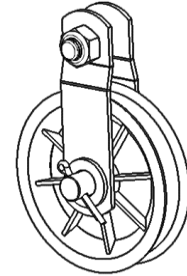

VEN91004

PLASTIC PULLEYS

CATALOG NUMBER	ITEM DESCRIPTION	SHIP WEIGHT		LIST PRICE
		LBS.	KGS.	
VEN91104	7/8" Nylon Swivel Pulley	0.045	0.02	
690400	7/8" Nylon Swivel Pulley - Stainless Steel	0.047	0.02	
VEN91101	1-7/8" Nylon Swivel Pulley	0.102	0.05	
VEN91102	1-7/8" Nylon Swivel Pulley	0.131	0.06	
ZR1801	1-7/8" Nylon Swivel Pulley - Stainless Steel	0.160	0.07	
VEN91103	1-7/8" Nylon Split Bracket Pulley	0.135	0.06	
VEN91004	3-1/2" Nylon Pulley	0.467	0.21	

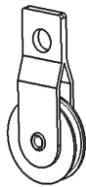

VEN91201

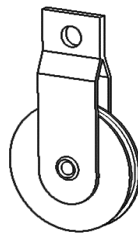

VEN91202

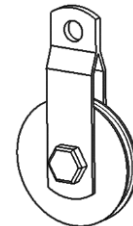

VEN91203

STAINLESS STEEL PULLEYS

CATALOG NUMBER	ITEM DESCRIPTION	SHIP WEIGHT		LIST PRICE
		LBS.	KGS.	
VEN91201	1-1/2" Steel Split Bracket Pulley	0.216	0.10	
VEN91202	2-1/2" Steel Split Bracket Pulley	0.540	0.24	
VEN91203	2-1/2" Steel Split Bracket Pulley With Bearing	0.574	0.26	

PULLEYS

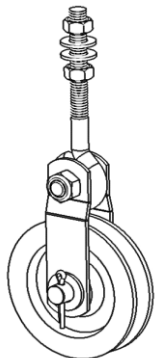

VEN91003

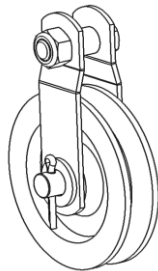

VEN91003A

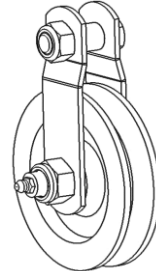

VEN91001

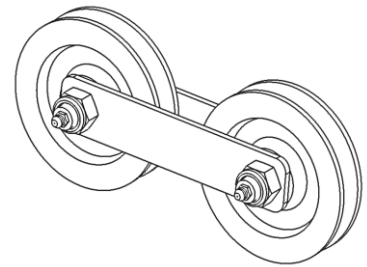

VEN91111

CAST IRON PULLEYS

CATALOG NUMBER	ITEM DESCRIPTION	SHIP WEIGHT		LIST PRICE
		LBS.	KGS.	
VEN91003	3-1/2" Cast Iron Pulley With Bronze Bushing - With Eyebolt	1.5	0.69	
VEN91003A	3-1/2" Cast Iron Pulley With Bronze Bushing - No Eyebolt	1.2	0.56	
VEN91001	3-1/2" Cast Iron Pulley With Needle Bearing - No Bolt	1.4	0.65	
VEN91111	Double Cast Pulley With Bronze Bushings	2.9	1.32	

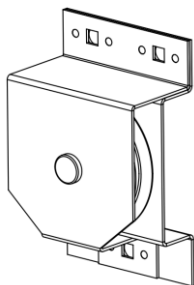

820167

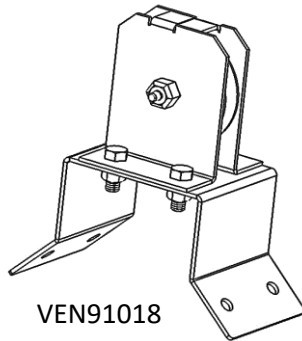

VEN91018

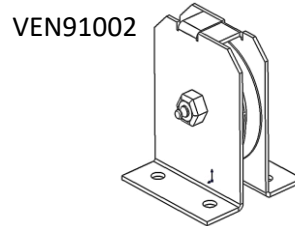

VEN91002

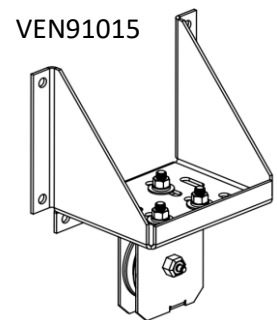

VEN91015

MOUNTED PULLEYS

CATALOG NUMBER	ITEM DESCRIPTION	SHIP WEIGHT		LIST PRICE
		LBS.	KGS.	
820167	3-1/2" Fiberglass Reinforced Nylon Horizontal	1.9	0.84	
VEN91002	3-1/2" Cast Iron With Needle Bearing Bushing	2.7	1.2	
VEN91005	4-1/2" Cast Iron Pulley with bracket	1.9	0.9	
VEN91018	Corner Pulley Kit	4.0	1.8	
VEN91015	Adjustable Wall Pulley Kit	6.4	2.9	

CABLE AND PULLEY ANCHOR BRACKETS

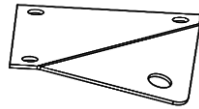

820162

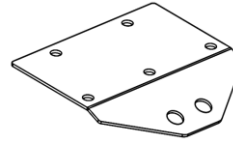

820163

Anchor Brackets

CATALOG NUMBER	ITEM DESCRIPTION	SHIP WEIGHT		LIST PRICE
		LBS.	KGS.	
820162	Single Pulley/Cable Anchor Bracket Requires (3) 3/8" Fasteners Accepts Pulleys VEN91004, VEN91003A, and VEN91001	1.2	0.55	
820163	Double Pulley Anchor Bracket Requires (5) 3/8" Fasteners Accepts Pulleys VEN91004, VEN91003A, and VEN91001	1.8	0.81	

Note: Pulleys (19-07 thru 19-08), Hardware (19-06), Cable (19-03), and Cable Accessories (19-03) Sold Separately

820162 BRACKET TYPICAL APPLICATIONS

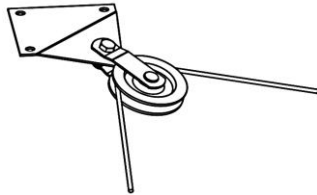

Pulley Anchor - Ceiling or Wall

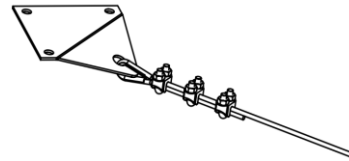

Cable Anchor Plate

820163 BRACKET TYPICAL APPLICATIONS

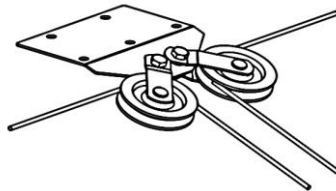

Pulley Anchor - Ceiling or Wall

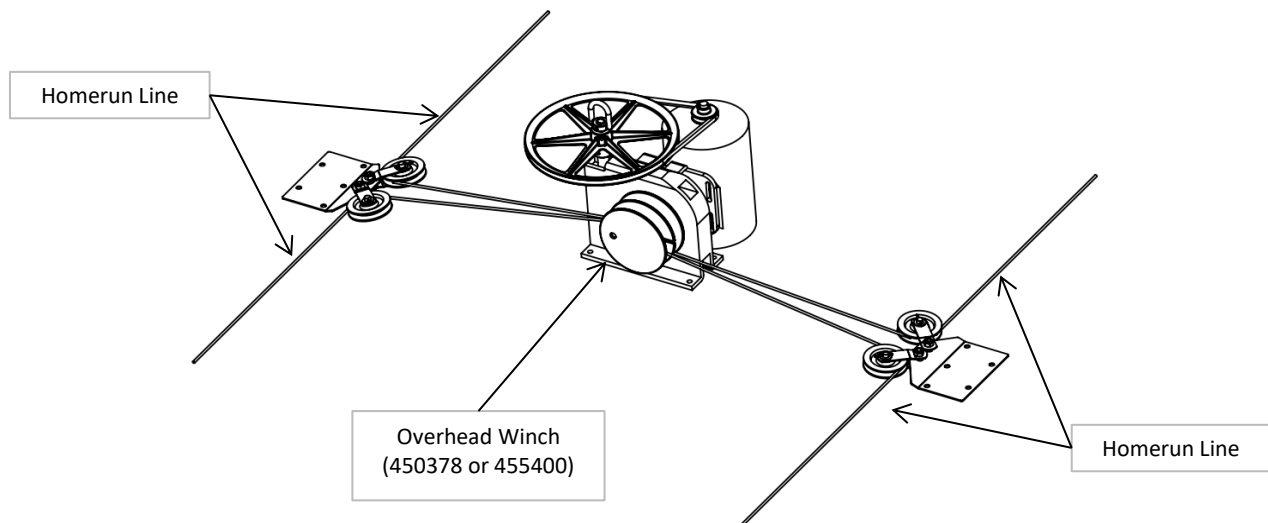

IMPORTANT: APPLIED LOADS MUST BE CONSIDERED WHEN CHOOSING AND INSTALLING WINCHING COMPONENTS.

CHAIN AND SPROCKETS

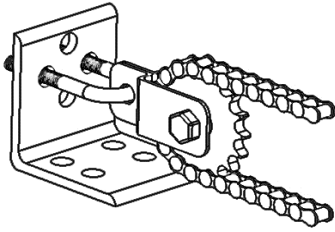

820026

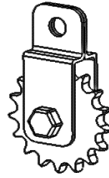

820027



820028

Chain and Sprockets

CATALOG NUMBER	ITEM DESCRIPTION	SHIP WEIGHT		LIST PRICE
		LBS.	KGS.	
820026	Sprocket and Chain Kit	0.8	0.4	
820027	Split Bracket Sprocket (For #40 Chain)	0.0	0.0	
820028	#40 Chain, 30" Length	0.0	0.0	



780017

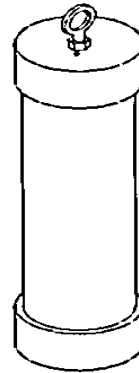

750014

Springs & Counterweights

CATALOG NUMBER	ITEM DESCRIPTION	SHIP WEIGHT		LIST PRICE
		LBS.	KGS.	
780017	18" 17-7 PH Stainless Steel Spring	1.7	0.8	
750014	Weight Assembly	10.2	4.6	