



SECTION 33 POLAIR HIGH PRESSURE FOG SYSTEM

IN THIS CATALOG SECTION

PAGE NUMBER	CONTENTS
33-02	Pumps
33-03	Filters
33-04	Controls, Sensors, Valves, Hoses, Main Line
33-05	Maintenance - Pump Oil, Regulators, Nozzles
33-06 thru 33-08	Atomization Lines
33-09 thru 33-11	Fittings
33-12	Suspension Hardware
33-13	Sentry Disinfectant Delivery System, Tools, Sample

**Please call customer service or your local representative for assistance
in quoting & ordering PolAir High Pressure Fog Systems.**



POLAIR HIGH PRESSURE FOG SYSTEM SYSTEM COMPONENTS

PUMP KITS

Unless otherwise stated, pumps do NOT include filter kits or controls

CATALOG #	Pressure (PSI)	Horsepower	Phase	Full Load Amps (A)	Input Hose Barb (in.)	SHIP WEIGHT		LIST PRICE
	Flow Rate (GPM)	Voltage (V)	Frequency (Hz)	400HC Req'd.	Output Fitting (MNPT in.)	LBS.	KG.	
1P / 50Hz								
814045	1000	0.75	1	10/5	0.5	130.0	58.9	
	0.35	110/220	50	None Includes: VE-010-001 23A	0.5			
1P / 60Hz								
814050	1000	0.75	1	8.4 / 4.2	0.50	126.1	57.2	
	0.45	115/208-230	60	None Includes: VE-010-001 23A	0.50			
814065	1000	3.0	1	28/15.5-14	0.50	157.0	71.2	
	2.1 - 3.7	115/208/230	60	43A / 23A	0.50			
814080	1000	5	1	25-23	0.50	206.0	93.4	
	3.3 - 6.0	208-230	60	43A	0.50			
814085	1000	7.5	1	31-29	0.75	345.0	156.5	
	4.9 - 8.9	208-230	60	43A	0.50			
814105	1000	10	1	38	1.00	441.3	200.2	
	7.2 - 12.9	230	60	43A	0.75			
3P / 50Hz								
814057	1000	2.0	3	6-5.8/2.9	0.50	76.0	34.5	
	0.9-1.6	190/380	50	23A	0.50			
814055	1000	3.0	3	8.5 - 4.9	0.50	152.0	68.9	
	1.8 - 3.1	230/400	50	23A	0.50			
814070	1000	5.0	3	13.8 / 8	0.50	208.0	94.3	
	2.8 - 5.0	230/400	50	23A	0.50			
814090	1000	7.5	3	11.2	0.75	354.7	160.9	
	4.3 - 7.8	400	50	23A	0.50			
3P / 60Hz								
814060	1000	3.0	3	9-8.4 / 4.2	0.50	147.7	67.0	
	2.1 - 3.8	208-230/460	60	23A	0.50			
814075	1000	5	3	13.9-13.4/6.7	0.50	200.0	90.7	
	3.4 - 6.1	208-230/460	60	23A	0.50			
814095	1000	7.5	3	19.8-19/9.8	0.75	398.5	180.8	
	5.0 - 9.0	208-230/460	60	23A	0.50			
814120	1000	15	3	38-36/18	1.00	502.3	227.9	
	15	208-230/460	60	43A / 23A	0.75			
814130	1000	15	3	38-36/18	1.00	530.6	240.7	
	11 - 19.8	208-230/460	60	43A / 23A	0.75			
814200	1500	15	3	38-36/19	1.00	563.8	255.7	
	7.3 - 13.1	208-230/460	60	43A	0.75			

POLAIR HIGH PRESSURE FOG SYSTEM SYSTEM COMPONENTS

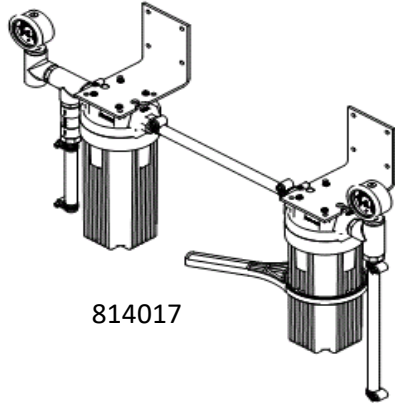

814017

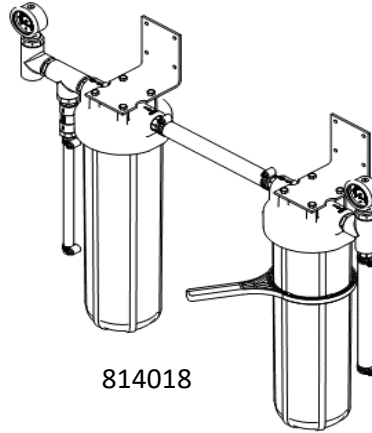

814018

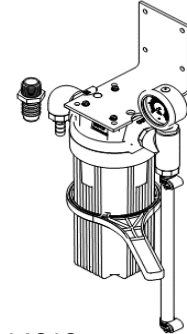

814019

FILTER KITS

Filter kits include filters and wrench for filter housing(s)

CATALOG #	ITEM DESCRIPTION	SHIP WEIGHT		LIST PRICE
		LBS.	KG.	
814017	Filter kit, 6 GPM, 5 & 1 micron .75" FNPT in, 0.5" hose out	19.2	8.7	
814018	Filter Kit, 12-30 GPM, 5 & 1 micron 1" FNPT in, 1" hose out	45.0	20.4	
814019	Filter Kit, 8GPM, Scale Inhibit, 1/2" or 1" HB in, 1/2" hose out, incl. 1 PM3P775 filter	11.0	5.0	

WATER TREATMENT - SCALE REMOVAL

For systems under 8GPM use PM3P775 filter cartridge for scale control. Larger systems use PM10TS Dispensing system and treatment solution

CATALOG #	ITEM DESCRIPTION	SHIP WEIGHT		LIST PRICE
		LBS.	KG.	
814019	Filter Kit, 8GPM, Scale Inhibit, 1/2" or 1" HB in, 1/2" hose out, incl. 1 PM3P775 filter	11.0	5.0	
PM10TS	Water Treatment System - incl. 230VAC pump, PMCPABU1	25.0	11.3	
PMCPABU1	Water Treatment Solution - 5 Gallon (PF) Treats up to 80,000 gallons at 3 ppm concentration	50.0	22.7	
PMOTKU62	Parafos Test Kit - Use with water treatment solution to determine residual levels - 40 tests/kit	0.0	0.0	

MAINTENANCE - FILTERS

CATALOG #	ITEM DESCRIPTION	SHIP WEIGHT		LIST PRICE
		LBS.	KG.	
PM3P775	Scale Inhibitor Filter 10"	1.1	0.5	
PMCLR1-10	1 Micron Water Filter 10"	0.4	0.2	
PMCLR-1-20	1 Micron Water Filter 20"	0.8	0.4	
PMFILT1MBIGBLUE	1 Micron Water Filter 20" wide (4.5")	3.5	1.6	
PMCLR-5-10	5 Micron Water Filter 10"	0.4	0.2	
PMCLR-5-20	5 Micron Water Filter 20" standard	0.8	0.4	
PMFILT5MBIGBLUE	5 Micron Water Filter 20" wide (4.5")	7.0	3.2	
PMCLR10-10	10 Micron Water Filter 10"	0.4	0.2	
PMCLR10-20	10 Micron Water Filer 20"	0.7	0.3	
PMFILTERWRENCH	Wrench for Standard Blue Housing	0.2	0.1	
PMBIGBLUEWRENCH	Wrench for Big Blue & Yellow Housings	0.2	0.1	

POLAIR HIGH PRESSURE FOG SYSTEM SYSTEM COMPONENTS

CONTROLS

400HC has inputs for up to 2 temp sensors and 1 Rh sensor or 2 external on/off signals
 400HC can control up to (2) Zone Valves

CATALOG #	ITEM DESCRIPTION	SHIP WEIGHT		LIST PRICE
		LBS.	KG.	
VE-010-000	POLAIR 400HC - No Contactor - 2 Stages Cooling	8.5	3.9	
VE-010-001	POLAIR 400HC - 23 Amp - 2 Stages Cooling	9.0	4.1	
VE-010-101	POLAIR 400HC - 43 Amp - 2 Stages Cooling	9.0	4.1	
VE-010-201	POLAIR 400HC - 60 Amp - 2 Stages Cooling	9.0	4.1	

SENSORS

CATALOG #	ITEM DESCRIPTION	SHIP WEIGHT		LIST PRICE
		LBS.	KG.	
SR-017-100	Temp Sensor	0.1	0.0	
PA-56	Relative Humidity Sensor	1.0	0.5	
ZC1150R	Sensor Wire - Per Foot	0.0	0.0	
ZC1150RL	Sensor Wire - 1,000 Foot Roll	23.0	10.4	
WS-27	Scotchlok - Wire Connector	0.0	0.0	

ZONE VALVES

Note that improper use of zone valves may result in significantly reduced pump life if zone valves cause pump to recirculate more than 50% of total pump output

CATALOG #	ITEM DESCRIPTION	SHIP WEIGHT		LIST PRICE
		LBS.	KG.	
PM1SC	1SC 24 Volt Zone Valve Snap Action	6.5	2.9	
PM1SCMTR24V1500CD	1SC 24 Volt Motorized Zone Valve - slow opening	14.0	6.4	
814005	Repair Kit, SS Zone Valve, For PM1SCMTR24V1500CD	1.0	0.5	

DRAIN VALVES

No more than (1) automatic drain valve for every GPM of pump flow

CATALOG #	ITEM DESCRIPTION	SHIP WEIGHT		LIST PRICE
		LBS.	KG.	
PMDV15-1	Automatic Drain Valve for 1/2" Atomization Line	2.3	1.1	
PMDVREPAIRKIT	Drain Valve Repair Kit for PMDV15-1	0.0	0.0	
PMDVWS	Drain Valve Washer - Split for PMDV15-1	0.0	0.0	
PMRBF LUSHKIT	Manual Drain Valve	2.3	1.1	

FLEXIBLE HIGH PRESSURE HOSES & BALL VALVES

CATALOG #	ITEM DESCRIPTION	SHIP WEIGHT		LIST PRICE
		LBS.	KG.	
PMHPHOSE40	High press. Flex hose - 1/2" MNPT swivel ends - 40" L	1.2	0.6	
PMHPHOSE3/4	High press. Flex hose - 3/4" MNPT swivel ends - 36" L	1.3	0.6	
PMBVL	High press. Locking Ball Valve, Brass - 1/2" FNPT ports	0.6	0.3	
PMBVSS1/2	High press. Ball Valve, SS - 1/2" FNPT ports	0.6	0.3	
PMBVL3-8	High press. Ball Valve, Brass - 3/8" FNPT ports	0.6	0.3	

MAIN LINE

CATALOG #	ITEM DESCRIPTION	SHIP WEIGHT		LIST PRICE
		LBS.	KG.	
814010	Tube, 1/2" OD 0.035W 18'L 316SS	2.1	1.0	
814011	Tube, 3/4" OD 0.035W 18'L 316SS	4.9	2.2	

POLAIR HIGH PRESSURE FOG SYSTEM SYSTEM COMPONENTS

MAINTENANCE - PUMP OIL

Pump oil should be changed after the first 50 hrs. and regularly every 300 hrs. or 3 months, whichever comes first

CATALOG #	ITEM DESCRIPTION	SHIP WEIGHT		LIST PRICE
		LBS.	KG.	
PMCAT6107	Cat Pump oil - ISO 68 - 21 oz (625cc) bottle	1.3	0.6	
814173	30W Oil, Non-detergent - 16 oz (475cc) bottle	1.0	0.6	
814177	50w Oil, GP SERIES 220, 2.5 Gallon	25.0	0.6	
814178	50w Oil, GP SERIES 220, 16OZ	1.2	0.6	
PMGPOIL100734	80/90W Oil, Non-detergent - 1 X 2.5 gal (9.45l) bottles	1.1	0.5	
PMGPOIL100735	80/90W Oil, Non-detergent - 2 X 2.5 gal (9.45l) bottles	41.8	19.0	
PMCAT34334	Drain Kit, Oil, CAT Pumps - No oil included	0.8	0.4	

PUMP #	ITEM DESCRIPTION	OIL REQUIRED	VOLUME
814045	PUMP HPF, Demo 1000PSI,0.35GPM .75HP, 110/220V, 1PH, 50HZ	814173	11.8 fl. Oz.
814050	PUMP HPF, Demo,1000PSI 0.45GPM .75HP, 115/208-230V, 1PH, 60HZ	814173	11.8 fl. Oz.
814055	PUMP, HPF, 1000PSI, 1.8-3.1GPM 3HP, 230/400V, 3PH, 50HZ	814173	14 fl. Oz.
814060	PUMP, HPF, 1000PSI, 2.1-3.8GPM 3HP, 208-230/460V, 3PH, 60HZ	814173	14 fl. Oz.
814065	PUMP HPF, 1000PSI, 2.1-3.7GPM 3HP, 115/208-230V, 1PH, 60HZ	814173	14 fl. Oz.
814070	PUMP, HPF, 1000PSI, 2.8-5.0GPM 5HP, 230/400V, 3PH, 50HZ	814173	37.2 fl. Oz.
814075	PUMP, HPF, 1000PSI, 3.4-6.1GPM 5HP, 208-230/460V, 3PH, 60HZ	814173	37.2 fl. Oz.
814080	PUMP HPF, 1000PSI, 3.3-6.0GPM 5HP, 208-230V, 1PH, 60HZ	814173	37.2 fl. Oz.
814085	PUMP HPF, 1000PSI, 4.9-8.9GPM 7.5HP, 208-230V, 1PH, 60HZ	814173	37.2 fl. Oz.
814090	PUMP, HPF, 1000PSI, 4.3-7.8GPM 7.5HP, 400V, 3PH, 50HZ	814173	37.2 fl. Oz.
814095	PUMP, HPF, 1000PSI, 5-9GPM 7.5HP, 208-230/460V, 3PH, 60HZ	814173	37.2 fl. Oz.
814105	PUMP HPF, 1000PSI, 7.2-12.9GPM 10HP, 230V, 1PH, 60HZ	814177 / 814178	64.2 fl. Oz.
814120	PUMP HPF, 1000PSI, 15GPM, 15HP 208-230/460V 3PH 60HZ	814177 / 814178	64.2 fl. Oz.
814200	PUMP HPF 1500PSI 7.3 - 13.1GPM 15HP 208-230/460V 3PH 60HZ	814177 / 814178	64.2 fl. Oz.

MAINTENANCE - REGULATORS

Regulators should be oiled every month with 4 drops of light household oil

CATALOG #	ITEM DESCRIPTION	SHIP WEIGHT		LIST PRICE
		LBS.	KG.	
PMBR5-2	Pressure Regulator, 5GPM (19 lpm), 750-2000psi (51 - 138 bar)	1.4	0.6	
PMBR5-2REB	Rebuil Kit, Pressure Regulator, 5GPM, 750-2000psi	1.4	0.6	
PMBR10-2	Pressure Regulator, 10GPM (38lpm), 750-2000psi (51 - 138 bar)	2.5	1.1	
PMBR10-2REB	Rebuild Kit, Pressure Regulator, 10GPM, 750-2000psi	0.0	1.1	
PMCAT7022	Pressure Regulator, 2.5 - 25 GPM (9 - 95 lpm), 500-2000psi (35 - 138 bar)	5.0	2.3	
PMCAT7595	Relief Valve, 53GPM max, 100-2600psi, 3/4" inlet, 1/2" outlet	1.8	0.8	

MAINTENANCE - NOZZLE LINES

CATALOG #	ITEM DESCRIPTION	SHIP WEIGHT		LIST PRICE
		LBS.	KG.	
814012R	Nozzle Assembly, 303 SS body and seals w/ check valve	0.0	0.1	
814184	1/2" Compression Brass Union with a Nozzle Assembly	0.3	0.1	
PMNS-F303	Seal, Flanged, 303SS for 814012 nozzle	0.0	0.1	
PMPLUG	Nozzle Plug, 303SS body and seal	0.0	0.1	
PMVC-312-8	Cap, Plastic, Re-useable for Nozzle protection	0.0	0.1	
PMNOZ8BRUSH	Wire Brush, SS, Special Nozzle Cleaning, Plastic Handle	0.0	0.1	

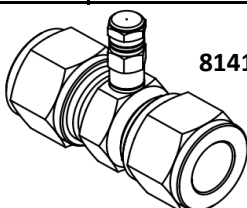

814184

814012R



PMNS-F303



PMPLUG

POLAIR HIGH PRESSURE FOG SYSTEM SYSTEM COMPONENTS ATOMIZATION LINES

INLINE NOZZLES

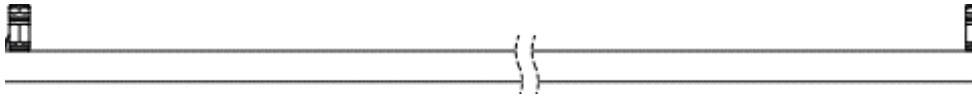

CATALOG #	ITEM DESCRIPTION	SHIP WEIGHT		LIST PRICE
		LBS.	KG.	
814001-001	LINE, 18' 1 NOZZLE INLINE, HP 216" [548.6 CM] SPACING	3.2	1.5	
814001-002	LINE, 18' 2 NOZZLE INLINE, HP108" [274.3 CM] SPACING	3.2	1.5	
814001-003	LINE, 18' 3 NOZZLE INLINE, HP72" [182.9 CM] SPACING	3.3	1.5	
814001-004	LINE, 18' 4 NOZZLE INLINE, HP54" [137.2 CM] SPACING	3.3	1.5	
814001-005	LINE, 18' 5 NOZZLE INLINE, HP43.2" [109.7 CM] SPACING	3.3	1.5	
814001-006	LINE, 18' 6 NOZZLE INLINE, HP36" [91.4 CM] SPACING	3.3	1.5	
814001-007	LINE, 18' 7 NOZZLE INLINE, HP30.86" [78.4 CM] SPACING	3.3	1.5	
814001-008	LINE, 18' 8 NOZZLE INLINE, HP27" [68.6 CM] SPACING	3.3	1.5	
814001-009	LINE, 18' 9 NOZZLE INLINE, HP24" [61 CM] SPACING	3.4	1.5	
814001-010	LINE, 18' 10 NOZZLE INLINE, HP21.6" [54.9 CM] SPACING	3.4	1.5	
814001-011	LINE, 18' 11 NOZZLE INLINE, HP19.64" [49.9 CM] SPACING	3.4	1.5	
814001-012	LINE, 18' 12 NOZZLE INLINE, HP18" [45.7 CM] SPACING	3.4	1.6	
814001-013	LINE, 18' 13 NOZZLE INLINE, HP16.62" [42.2 CM] SPACING	3.4	1.6	
814001-014	LINE, 18' 14 NOZZLE INLINE, HP15.43" [39.2 CM] SPACING	3.4	1.6	
814001-015	LINE, 18' 15 NOZZLE INLINE, HP14.4" [36.6 CM] SPACING	3.5	1.6	
814001-016	LINE, 18' 16 NOZZLE INLINE, HP13.5" [34.3 CM] SPACING	3.5	1.6	
814001-017	LINE, 18' 17 NOZZLE INLINE, HP12.71" [32.3 CM] SPACING	3.5	1.6	
814001-018	LINE, 18' 18 NOZZLE INLINE, HP12" [30.5 CM] SPACING	3.5	1.6	
814001-019	LINE, 18' 19 NOZZLE INLINE, HP11.37" [28.9 CM] SPACING	3.6	1.6	
814001-020	LINE, 18' 20 NOZZLE INLINE, HP10.8" [27.4 CM] SPACING	3.6	1.6	
814001-021	LINE, 18' 21 NOZZLE INLINE, HP10.29" [26.1 CM] SPACING	3.6	1.6	
814001-022	LINE, 18' 22 NOZZLE INLINE, HP9.82" [24.9 CM] SPACING	3.6	1.6	
814001-025	LINE, 18' 25 NOZZLE INLINE, HP8.64" [21.9 CM] SPACING	3.6	1.6	
814001-026	LINE, 18' 26 NOZZLE INLINE, HP8.31" [21.1 CM] SPACING	3.7	1.7	
814001-028	LINE, 18' 28 NOZZLE INLINE, HP7.71" [19.6 CM] SPACING	3.7	1.7	
814001-030	LINE, 18' 30 NOZZLE INLINE, HP7.2" [18.3 CM] SPACING	3.7	1.7	
814001-032	LINE, 18' 32 NOZZLE INLINE, HP6.75" [17.1 CM] SPACING	3.8	1.7	
814001-034	LINE, 18' 34 NOZZLE INLINE, HP6.35" [16.1 CM] SPACING	3.8	1.7	
814001-036	LINE, 18' 36 NOZZLE INLINE, HP6" [15.2 CM] SPACING	3.8	1.7	

POLAIR HIGH PRESSURE FOG SYSTEM SYSTEM COMPONENTS ATOMIZATION LINES

180° ALTERNATING NOZZLES

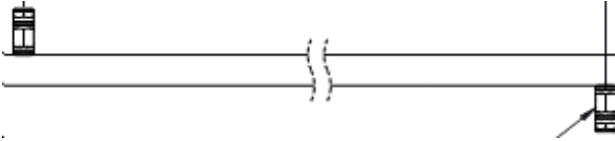

CATALOG #	ITEM DESCRIPTION	SHIP WEIGHT		LIST PRICE
		LBS.	KG.	
814002-002	LINE, 18' 2 NOZZLE ALTNAT, HP108" [274.3 CM] SPACING	3.2	1.5	
814002-003	LINE, 18' 3 NOZZLE ALTNAT, HP72" [182.9 CM] SPACING	3.2	1.5	
814002-004	LINE, 18' 4 NOZZLE ALTNAT, HP54" [137.2 CM] SPACING	3.3	1.5	
814002-005	LINE, 18' 5 NOZZLE ALTNAT, HP43.2" [109.7 CM] SPACING	3.3	1.5	
814002-006	LINE, 18' 6 NOZZLE ALTNAT, HP36" [91.4 CM] SPACING	3.3	1.5	
814002-007	LINE, 18' 7 NOZZLE ALTNAT, HP30.86" [78.4 CM] SPACING	3.3	1.5	
814002-008	LINE, 18' 8 NOZZLE ALTNAT, HP27" [68.6 CM] SPACING	3.3	1.5	
814002-009	LINE, 18' 9 NOZZLE ALTNAT, HP24" [61 CM] SPACING	3.4	1.5	
814002-010	LINE, 18' 10 NOZZLE ALTNAT, HP21.6" [54.9 CM] SPACING	3.4	1.5	
814002-011	LINE, 18' 11 NOZZLE ALTNAT, HP19.64" [49.9 CM] SPACING	3.4	1.5	
814002-012	LINE, 18' 12 NOZZLE ALTNAT, HP18" [45.7 CM] SPACING	3.4	1.5	
814002-013	LINE, 18' 13 NOZZLE ALTNAT, HP16.62" [42.2 CM] SPACING	3.4	1.6	
814002-014	LINE, 18' 14 NOZZLE ALTNAT, HP15.43" [39.2 CM] SPACING	3.4	1.6	
814002-015	LINE, 18' 15 NOZZLE ALTNAT, HP14.4" [36.6 CM] SPACING	3.5	1.6	
814002-016	LINE, 18' 16 NOZZLE ALTNAT, HP13.5" [34.3 CM] SPACING	3.5	1.6	
814002-017	LINE, 18' 17 NOZZLE ALTNAT, HP12.71" [32.3 CM] SPACING	3.5	1.6	
814002-018	LINE, 18' 18 NOZZLE ALTNAT, HP12" [30.5 CM] SPACING	3.5	1.6	
814002-019	LINE, 18' 19 NOZZLE ALTNAT, HP11.37" [28.9 CM] SPACING	3.5	1.6	
814002-020	LINE, 18' 20 NOZZLE ALTNAT, HP10.8" [27.4 CM] SPACING	3.5	1.6	
814002-021	LINE, 18' 21 NOZZLE ALTNAT, HP10.29" [26.1 CM] SPACING	3.6	1.6	
814002-022	LINE, 18' 22 NOZZLE ALTNAT, HP9.82" [24.9 CM] SPACING	3.6	1.6	
814002-025	LINE, 18' 25 NOZZLE ALTNAT, HP8.64" [21.9 CM] SPACING	3.6	1.6	
814002-026	LINE, 18' 26 NOZZLE ALTNAT, HP8.31" [21.1 CM] SPACING	3.7	1.7	
814002-028	LINE, 18' 28 NOZZLE ALTNAT, HP7.71" [19.6 CM] SPACING	3.7	1.7	
814002-030	LINE, 18' 30 NOZZLE ALTNAT, HP7.2" [18.3 CM] SPACING	3.7	1.7	
814002-032	LINE, 18' 32 NOZZLE ALTNAT, HP6.75" [17.1 CM] SPACING	3.8	1.7	
814002-034	LINE, 18' 34 NOZZLE ALTNAT, HP6.35" [16.1 CM] SPACING	3.8	1.7	
814002-036	LINE, 18' 36 NOZZLE ALTNAT, HP6" [15.2 CM] SPACING	3.8	1.7	



POLAIR HIGH PRESSURE FOG SYSTEM SYSTEM COMPONENTS ATOMIZATION LINES

90° NOZZLES

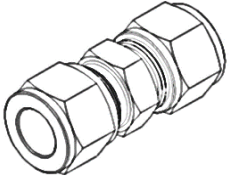
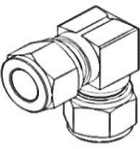
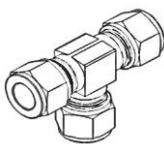
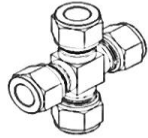

CATALOG #	ITEM DESCRIPTION	SHIP WEIGHT		LIST PRICE
		LBS.	KG.	
814003-002	LINE, 18' 2 NOZZLE 90 DEG, HP108" [274.3 CM] SPACING	3.2	1.5	
814003-003	LINE, 18' 3 NOZZLE 90 DEG, HP72" [182.9 CM] SPACING	3.3	1.5	
814003-004	LINE, 18' 4 NOZZLE 90 DEG, HP54" [137.2 CM] SPACING	3.3	1.5	
814003-005	LINE, 18' 5 NOZZLE 90 DEG, HP43.2" [109.7 CM] SPACING	3.3	1.5	
814003-006	LINE, 18' 6 NOZZLE 90 DEG, HP36" [91.4 CM] SPACING	3.3	1.5	
814003-007	LINE, 18' 7 NOZZLE 90 DEG, HP30.86" [78.4 CM] SPACING	3.3	1.5	
814003-008	LINE, 18' 8 NOZZLE 90 DEG, HP27" [68.6 CM] SPACING	3.3	1.5	
814003-009	LINE, 18' 9 NOZZLE 90 DEG, HP24" [61 CM] SPACING	3.4	1.5	
814003-010	LINE, 18' 10 NOZZLE 90 DEG, HP21.6" [54.9 CM] SPACING	3.4	1.5	
814003-011	LINE, 18' 11 NOZZLE 90 DEG, HP19.64" [49.9 CM] SPACING	3.4	1.5	
814003-012	LINE, 18' 12 NOZZLE 90 DEG, HP18" [45.7 CM] SPACING	3.4	1.6	
814003-013	LINE, 18' 13 NOZZLE 90 DEG, HP16.62" [42.2 CM] SPACING	3.4	1.6	
814003-014	LINE, 18' 14 NOZZLE 90 DEG, HP15.43" [39.2 CM] SPACING	3.5	1.6	
814003-015	LINE, 18' 15 NOZZLE 90 DEG, HP14.4" [36.6 CM] SPACING	3.5	1.6	
814003-016	LINE, 18' 16 NOZZLE 90 DEG, HP13.5" [34.3 CM] SPACING	3.5	1.6	
814003-017	LINE, 18' 17 NOZZLE 90 DEG, HP12.71" [32.3 CM] SPACING	3.5	1.6	
814003-018	LINE, 18' 18 NOZZLE 90 DEG, HP12" [30.5 CM] SPACING	3.5	1.6	
814003-019	LINE, 18' 19 NOZZLE 90 DEG, HP11.37" [28.9 CM] SPACING	3.6	1.6	
814003-020	LINE, 18' 20 NOZZLE 90 DEG, HP10.8" [27.4 CM] SPACING	3.6	1.6	
814003-021	LINE, 18' 21 NOZZLE 90 DEG, HP10.29" [26.1 CM] SPACING	3.6	1.6	
814003-022	LINE, 18' 22 NOZZLE 90 DEG, HP9.82" [24.9 CM] SPACING	3.6	1.6	
814003-025	LINE, 38' 25 NOZZLE 90 DEG, HP8.64" [21.9 CM] SPACING	3.6	1.6	
814003-026	LINE, 18' 26 NOZZLE 90 DEG, HP8.31" [21.1 CM] SPACING	3.7	1.7	
814003-028	LINE, 18' 28 NOZZLE 90 DEG, HP7.71" [19.6 CM] SPACING	3.7	1.7	
814003-030	LINE, 18' 30 NOZZLE 90 DEG, HP7.2" [18.3 CM] SPACING	3.7	1.7	
814003-032	LINE, 18' 32 NOZZLE 90 DEG, HP6.75" [17.1 CM] SPACING	3.8	1.7	
814003-034	LINE, 18' 34 NOZZLE 90 DEG, HP6.35" [16.1 CM] SPACING	3.8	1.7	
814003-036	LINE, 18' 36 NOZZLE 90 DEG, HP6" [15.2 CM] SPACING	3.8	1.7	

POLAIR HIGH PRESSURE FOG SYSTEM SYSTEM COMPONENTS FITTINGS

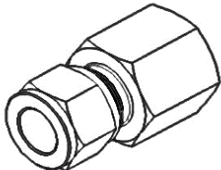
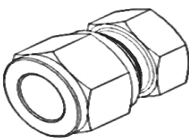
ITEM DESCRIPTION		MATERIAL	CATALOG NUMBER	LIST PRICE	
Tube Straight		1/2" Tube - 1/2" Tube	St. Steel	PMSS8U316	
			Brass	PMCF20	
		3/4" Tube - 1/2" Tube	St. Steel	PMSS12RU8316	
			Brass	PM12RU8	
		3/4" Tube - 3/4" Tube	St. Steel	PMSS12U316	
			Brass	PM12UBR	
Tube Elbow		1/2" Tube	St. Steel	PMSS8LU316	
			Brass	PMCF21	
		3/4" Tube	St. Steel	PMSS12LU316	
			Brass	PM12LUBR	
Tube Tee		1/2" Tube	St. Steel	PMSS8TTT316	
			Brass	PMCF22	
		3/4" Tube	St. Steel	PMSS12TTT316	
			Brass	PM12TTTBR	
Tube Cross		1/2" Tube	St. Steel	PMSS8C316	
			Brass		
		3/4" Tube	St. Steel	PMSS12C316	
			Brass		
Tube to MNPT		1/2" Tube - 3/8" MNPT	St. Steel	PMSS8CM6316	
			Brass	PMCF10	
		1/2" Tube - 1/2" MNPT	St. Steel	PMSS8CM8316	
			Brass	PMCF24	
		3/4" Tube - 1/2" MNPT	St. Steel		
			Brass	PM12CM8BR	
		3/4" Tube - 3/4" MNPT	St. Steel	PMSS12CM12316	
			Brass		
		1" Tube - 1" MNPT	St. Steel	PMSS16CM16316	
			Brass		
Tube to FNPT		1/2" Tube - 1/2" FNPT	St. Steel	PMSS8CF8316	
			Brass	PMCF23	
		1/2" Tube - 3/4" FNPT	St. Steel		
			Brass	PMCF8CF12BR	
		3/4" Tube - 3/4" FNPT	St. Steel		
			Brass	PM12CF12BR	
Tube Cap		1/2" Tube	St. Steel	PMSS8CP316	
			Brass	PMCF8CPBR	
		3/4" Tube	St. Steel	PM12CP	
			Brass		

POLAIR HIGH PRESSURE FOG SYSTEM SYSTEM COMPONENTS FITTINGS

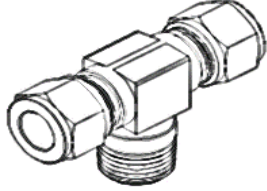
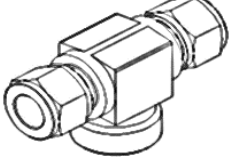
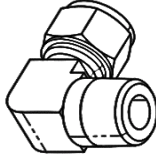
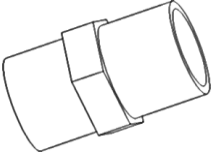
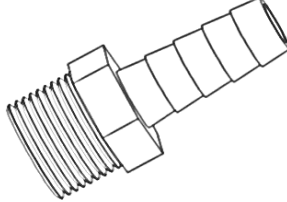
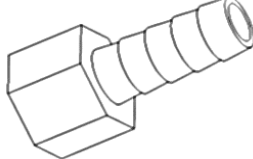
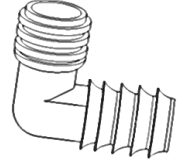
ITEM DESCRIPTION		MATERIAL	CATALOG NUMBER	LIST PRICE
Tube T X MNPT		1/2" Tube x 3/8" MNPT	St. Steel	
			Brass	PMCF28
		1/2" Tube x 1/2" MNPT	St. Steel	PMSS8ST8316
			Brass	PMCF25
		3/4" Tube x 1/2" MNPT	St. Steel	
			Brass	PM12TTM8BR
Tube T X FNPT		1/2" Tube x 3/8" MNPT	St. Steel	
			Brass	
		1/2" Tube x 1/2" MNPT	St. Steel	PMSS8TTF8316
			Brass	
Elbow to MNPT		1/2" Tube x 1/2" MNPT	St. Steel	PMSS8LM8316
			Brass	PMCF26
			St. Steel	
			Brass	
FNPT X FNPT		1/2" FNPT - 1/2" FNPT	St. Steel	PMSC36906113
			Brass	PMBFCOUPPING1/2
		3/4" FNPT - 3/4" FNPT	St. Steel	
			Brass	PMBFCOUPPING3/4
		1" FNPT - 1" FNPT	St. Steel	
			Brass	
MNPT X HB		1/2" MNPT - 1/2" Hose	St. Steel	
			Brass	PMHB1/2
		3/4" MNPT - 3/4" Hose	St. Steel	
			Brass	PMHB3/4
		1" MNPT - 1" Hose	St. Steel	
			Brass	PMHB1
FNPT X HB		1/2" FNPT - 1/2" Hose	St. Steel	
			Brass	PMHB1/2F
		3/8" FNPT - 1/2" Hose	St. Steel	
			Brass	
MNPT X HB 90°		1/2" MNPT - 3/8" Hose	St. Steel	
			Brass	PMHB1/2X3/890
		1/2" MNPT - 1/2" Hose	St. Steel	
			Brass	PMHB1/290

POLAIR HIGH PRESSURE FOG SYSTEM SYSTEM COMPONENTS FITTINGS

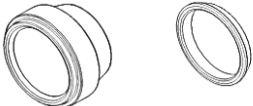
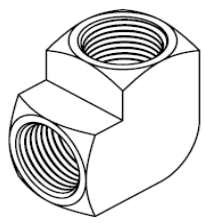
ITEM DESCRIPTION			Material	CATALOG NUMBER	LIST PRICE
Tube Ferules		1/2" SS	Front	PM8FF316	
			Rear	PM8FR316	
Tube Ferules		3/4" SS	Front	PM12FF316	
			Rear	PM12FR316	
Brass Elbow FNPT		1/2" FNPT x 1/2" FNPT	St. Steel		
			Brass	PMBF90X1/2	
		3/4" FNPT x 3/4" FNPT	St. Steel		
			Brass	PMBF90X3/4	

POLAIR HIGH PRESSURE FOG SYSTEM SYSTEM COMPONENTS

SUSPENSION HARDWARE

Support HPF tubing every 6' if directly attached to a solid structure;

Support every 2' if attached to a horizontal cable, cable attached every 8' to a solid structure

CATALOG #	ITEM DESCRIPTION	SHIP WEIGHT		LIST PRICE
		LBS.	KG.	
PMKGHK4	Tube Clamp, Rubber-lined, Single, 1/2" with Mounting Baseplate	0.2	0.11	
PMKGHK5	Tube Clamp, Rubber-lined, Double, 1/2" with Mounting Baseplate	0.3	0.13	
PMKGHK6	Tube Clamp, Rubber-lined, Single, 3/4" with Mounting Baseplate	0.0	0.00	
PMKGHK7	Tube Clamp, Rubber-lined, Double, 3/4" with Mounting Baseplate	0.0	0.00	
PMSTRAP375	Tube Strap, 3/8"	0.0	0.01	
PMSTRAP50	Tube Strap, Rubber-lined, 1/2" - Box of 100	1.8	0.80	
PMSTRAP75	Tube Strap, 3/4" - Box of 100	2.2	1.00	
690175	Screw, #12 X 1-1/2, TEK, Plate HexX Washer Head	0.0	0.01	
PM2H4CADDY	Hanger Clip, Hammer-On, 3/32" - 9/64" Thickness Flange	0.0	0.00	
PM4H24CLIP	Hanger Clip, Hammer-On, 1/4" Thickness Flange	0.0	0.01	
PMCABL1000SS	Cable, SS, 7 X 7, 1/16" - 1000' Roll	8.1	3.69	
PMTIGHT	Cable Tightener, 9" - for SS Cable (1 for every 100' of cable)	0.8	0.36	
PMSLEEVE	Cable Sleeve, Aluminum - for SS Cable (requires swage tool)	0.0	0.00	
PMTT6	Wire Tie, UV-Resistant, Black, 7.5"	0.0	0.00	

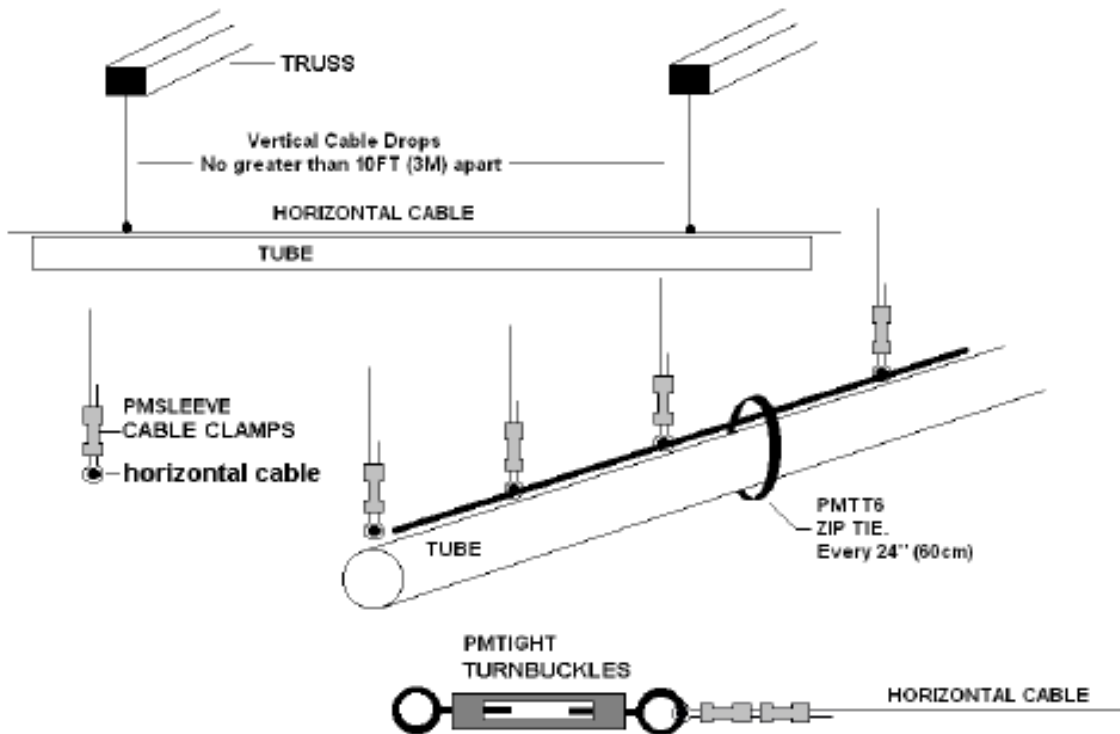

VERTICAL CABLE DROPS AND HORIZONTAL CABLE RUNS

POLAIR HIGH PRESSURE FOG SYSTEM SYSTEM COMPONENTS

TOOLS

CATALOG #	ITEM DESCRIPTION	SHIP WEIGHT		LIST PRICE
		LBS.	KG.	
PMPIPECUTTER	SS Pipe Cutter	1.0	0.45	
PMFLEXTUBECUTTER	Nylon Tubing Cutter	0.1	0.05	
PMSWAGETOOL	Swage Tool, Manual, 1/16"	1.0	0.45	
VC300	Cable Cutter, Manual, 3/16" - Model RC-8	0.0	0.00	
PM8-2829S-I	Tube Bender 1/2"	0.0	0.00	
PMTEF30	Teflon Tape, Roll, 1/2" x 520"	0.0	0.01	

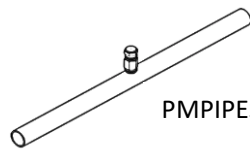

PMPIPESAMP8

SAMPLES

CATALOG #	ITEM DESCRIPTION	SHIP WEIGHT		LIST PRICE
		LBS.	KG.	
PMPIPESAMP8	Atomization Line Sample - Length 21cm / 8.3" with 1 nozzle	0.1	0.06	

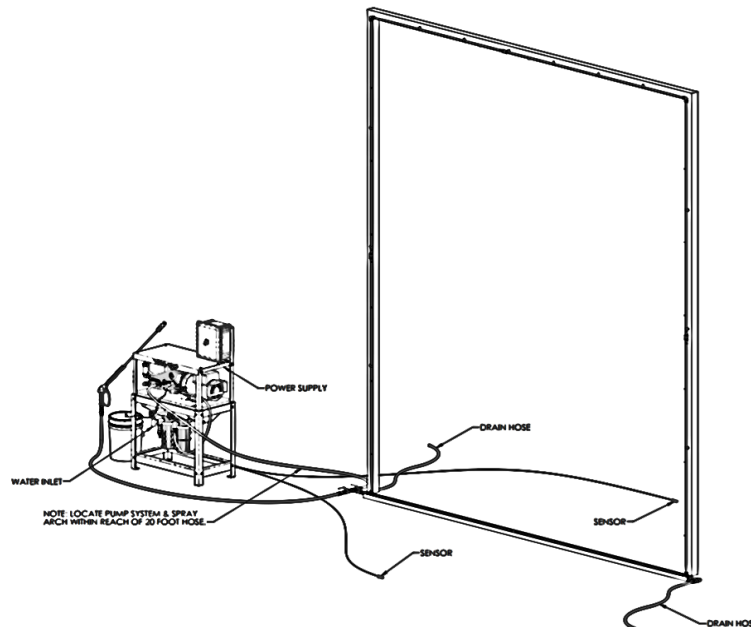

Sentry Automatic Disinfectant Delivery System For Biosecurity

Each package includes the Sentry Pump, Controller and Filtration System, Sentry Fog Nozzles installed in Stainless Steel Tube, Spray Wand, 2 Automatic Sensors and Chemical Injector.

Sentry Disinfectant System

CATALOG #	ITEM DESCRIPTION	SHIP WEIGHT		LIST PRICE
		LBS.	KG.	
814150	Sentry System. Main Power: 220V 50Hz 1Phase Controller Power: 220V 50Hz 1Phase	224.7	101.9	
814155	Sentry System. Main Power: 230/400V 50Hz 3Phase Controller Power: 220V 50Hz 1Phase	281.5	127.7	
814160	Sentry System. Main Power: 230V 60Hz 1Phase Controller Power: 230V 60Hz 1Phase	279.5	126.8	
814165	Sentry System. Main Power: 208-230/460V 60Hz 3Phase Controller Power: 230V 60Hz 1Phase	273.5	124.1	



This Page Intentionally Left Blank